

Part 1 Naming convention

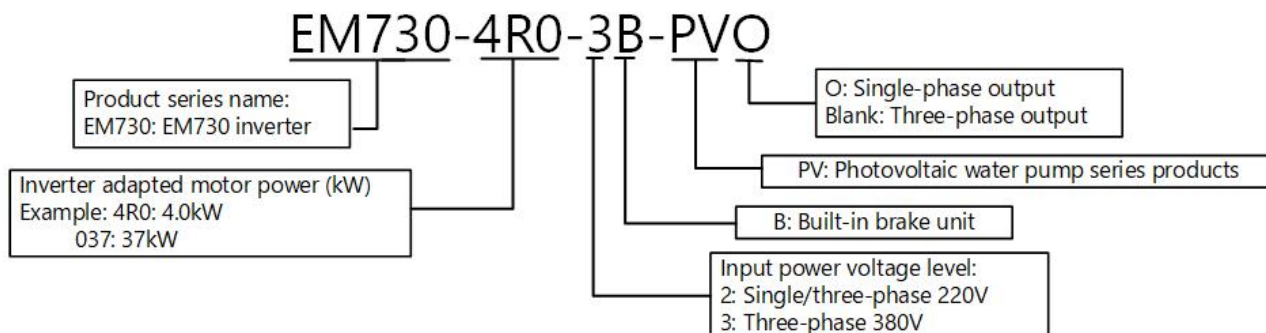

Part 2 Product Model

Rated power supply voltage	Model	Applicable motor power (kW)	Rated output current (A)
Single-phase output Single-phase/three-phase AC 200~240V input/ Single-phase DC 200~400V input	EM730-0R4-2B-PVO	0.4	4.8
	EM730-0R7-2B-PVO	0.75	8.0
	EM730-1R5-2B-PVO	1.5	10
	EM730-2R2-2B-PVO	2.2	17
	EM730-4R0-2B-PVO	4.0	32
Single-phase/three-phase AC 200~240V input/ Single-phase DC 200~400V input	EM730-0R4-2B-PV	0.4	2.8
	EM730-0R7-2B-PV	0.75	4.8
	EM730-1R5-2B-PV	1.5	8
	EM730-2R2-2B-PV	2.2	10
Three-phase AC 340~460V input/ Single-phase DC 250~900V input	EM730-0R7-3B-PV	0.75	2.5
	EM730-1R5-3B-PV	1.5	4.2
	EM730-2R2-3B-PV	2.2	5.6
	EM730-4R0-3B-PV	4.0	9.4
	EM730-5R5-3B-PV	5.5	13
	EM730-7R5-3B-PV	7.5	17
	EM730-011-3B-PV	11	25
	EM730-015-3B-PV	15	32
	EM730-018-3B-PV	18.5	38
	EM730-022-3B-PV	22	45
	EM730-030-3/3B-PV	30	60
	EM730-037-3/3B-PV	37	75
	EM730-045-3-PV	45	90
	EM730-055-3-PV	55	110
	EM730-075-3-PV	75	150
EM730-090-3-PV	90	176	
EM730-110-3-PV	110	210	

Part 3 Product Specifications

Item		Specification
Power supply	Rated voltage of power supply	2B: MPPT Range 200~400VDC; Single phase/Three phase AC 200V-10%~240V+10%; 50/60HZ 3/3B : MPPT Range 250~900VDC; Three phase AC 340V-10%~460V+10%; 50/60HZ
	Maximum output voltage	The maximum output voltage is the same as the input power voltage.
Output	Rated output current	Continuous output of 100% rated current
	Maximum overload current	150% rated current 60s 120% rated current 60s
Basic control functions	Drive mode	V/F control (VVF); speed sensorless vector control (SVC)
	Input mode	Frequency (speed) input, torque input
	Start and stop control mode	Keyboard, control terminal (two-line control and three-line control), communication
	Frequency control range	0.00~600.00Hz/0.0~3000.0HZ
	Input frequency resolution	Digital input: 0.01Hz/0.1Hz Analog input: 0.1% of maximum frequency
	Speed control range	1:50 (VVF), 1:200 (SVC)
	Speed control accuracy	Rated synchronous speed \pm 0.2%
	Acceleration and deceleration time	0.01 s to 600.00 s / 0.1 s to 6,000.0 s / 1 s to 60,000 s
	Voltage/frequency characteristics	Rated output voltage: 20% to 100%, adjustable Reference frequency: 1Hz to 600Hz/3,000Hz
	Torque boost	Fixed torque boost curve Any V/F curve is acceptable.
	Starting torque	150%/1Hz (VVF) 150%/0.25Hz (SVC)
	Torque control accuracy	\pm 8% rated torque (SVC)
	Self-adjustment of output voltage	When the input voltage changes, the output voltage will basically remain unchanged.
	Automatic current limit	Output current is automatically limited to avoid frequent overcurrent protection actions.
	Input and output function	DC braking
Signal input source		Communication, multi-speed, analog, etc.
Reference power supply		10V/20mA
Terminal control power		24V/100mA
Digital input terminal	Digital input terminal	5-channel digital multi-function input: X1~X5 X5 can be used as the high-speed pulse input (max 100kHz).
	Analog input terminal	2-channel analog inputs: One (AI1) voltage source: -10 to 10V input;

EM730 Solar Pump Inverter User Manual V1.0

Item		Specification
		One channel (AI2): 0 to 10V input voltage or 0 to 20mA input current optional;
	Digital output terminal	Multi-function output of one open collector and one relay Maximum output current of the collector: 50mA; Relay contact capacity: 250VAC/3A or 30VDC/1A, EA-EC: normally open; EB-EC: normally closed
	Analog output terminal	One multi-function analog terminal output M1: 0-10V/0-20mA multi-function analog output terminal
Keyboard	LED display	The LED digital tube displays relevant information about the inverter.
Protection	Protective Function	Short circuit, overcurrent, overvoltage, undervoltage, phase loss, overload, overheat, load loss, external protection, water source water shortage protection, water pump dry-run/underload protection (Dry-run protection), reservoir full protection, light-weak sleep and wake-up/low voltage input protection, water pump stalled overload protection etc.
Use conditions	Location	Indoor, at an altitude of less than 1 km, free of dust, corrosive gases and direct sunlight. When the altitude is higher than 1km, it is derated by 1% per 100m. The maximum allowable altitude is 3km.
	Applicable environment	-10°C to +50°C, 5% to 95%RH (no condensation). When the ambient temperature exceeds 50°C, it needs to be derated by 3% per 1°C temperature rise. The maximum allowable ambient temperature is 60°C.
	Vibration	Less than 0.5g
	Storage environment	-40°C~+70°C
	Installation method	Wall-mounted or installed in the cabinet
Levels of protection		IP20/IP21 (with plastic baffle)
Cooling method		Forced air cooling

Part 4 Product size

4.1 Product appearance drawings

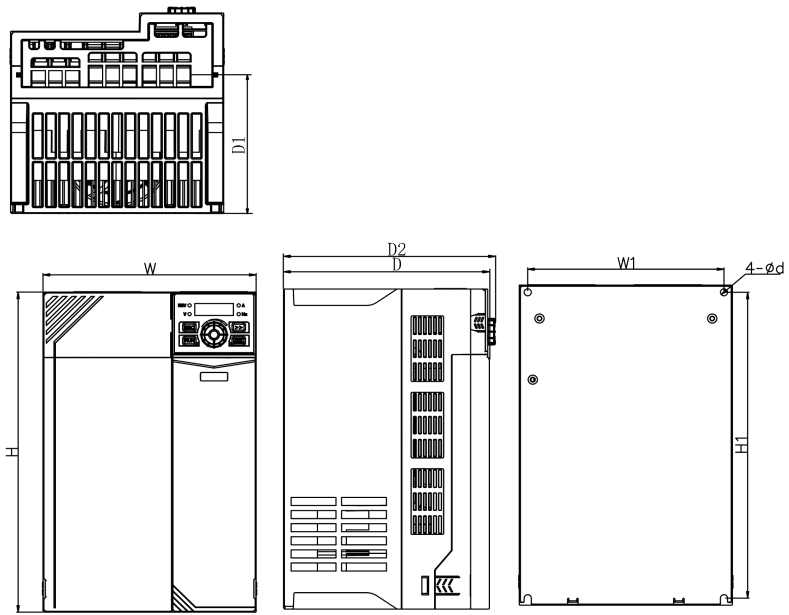

(a)

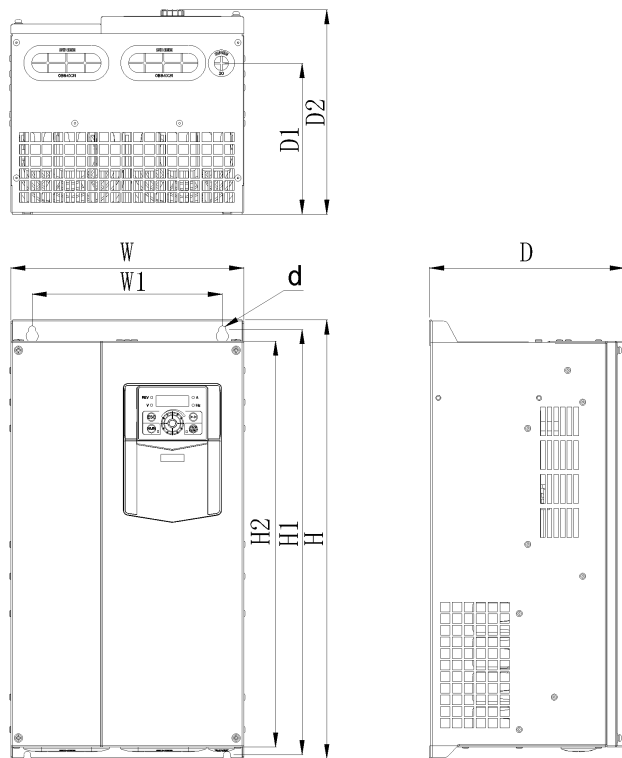

(b)

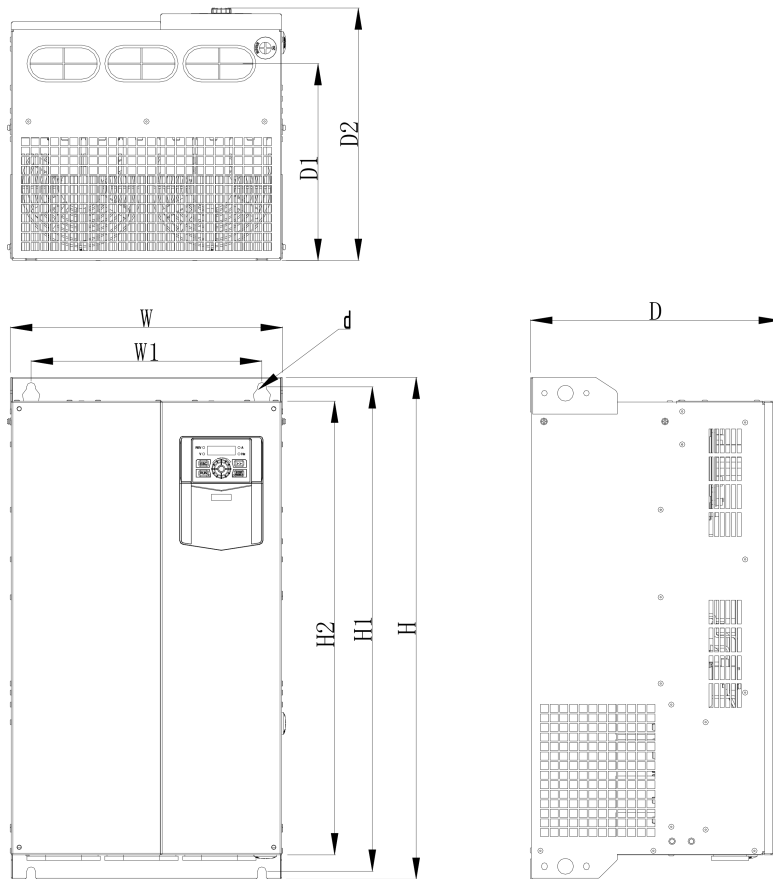

(c)

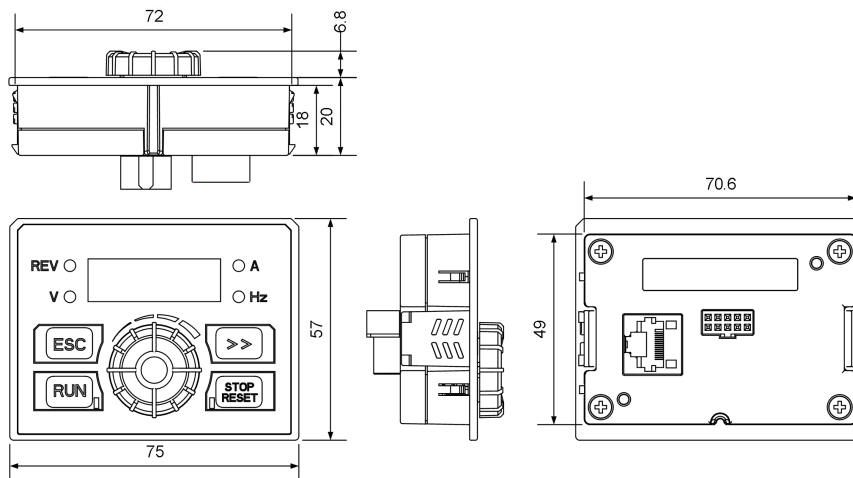

(d) EM730-PV keyboard appearance

4.2 Product size table

Specifications	W	W1	H	H1	H2	D	D1	D2	d	appearance
EM730-0R4-2B-PV	75	65	142	132		146	67	152	4.5	a
EM730-0R7-2B-PV										
EM730-0R4-2B-PVO										
EM730-1R5-2B-PV	93	82	172	163		136	85	141	4.7	
EM730-0R7-2B-PVO										
EM730-1R5-2B-PVO										
EM730-2R2-2B-PV	75	65	142	132		146	67	152	4.5	
EM730-0R7-3B-PV										
EM730-1R5-3B-PV										
EM730-2R2-3B-PV	93	82	172	163		136	85	141	4.7	
EM730-4R0-3B-PV										
EM730-2R2-2B-PVO										
EM730-5R5-3B-PV	109	98	207	196		154	103	160	5.5	
EM730-7R5-3B-PV										
EM730-4R0-2B-PVO										
EM730-011-3B-PV	136	125	250	240		169	115	174	5.5	
EM730-015-3B-PV										
EM730-018-3B-PV										
EM730-022-3B-PV	190	175	293	280		184	145	189	6.5	
EM730-030-3-PV										
EM730-030-3B-PV										
EM730-037-3-PV	245	200	454	440	420	205	156	212	7.5	b
EM730-037-3B-PV										
EM730-045-3-PV										
EM730-055-3-PV	300	266	524	508	480	229	174	236	9	
EM730-075-3-PV										
EM730-090-3-PV										
EM730-110-3-PV	335	286	630	608	570	310	247	317	11	c
EM730-110-3-PV										

Part 5 Main circuit terminal wiring

5.1 Main circuit terminal composition

Terminal	Terminal Definition
PB	Braking resistor terminals
+	
-	
R/L1	AC power input terminal
S/L2	
T/L3	
U	Motor terminal
V	
W	
\perp	Grounding

5.2 Main circuit terminal arrangement

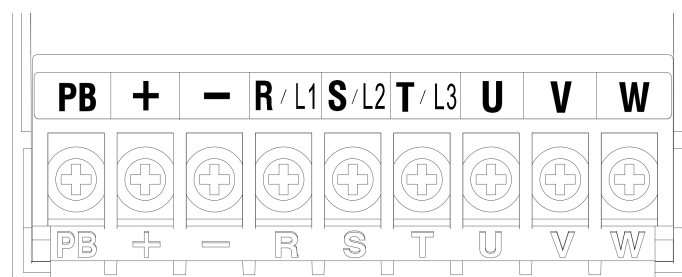

(a) Schematic Diagram of Terminals (EM730-0R7-3B-PV~EM730-1R5-3B-PV)

Note:

EM730-0R4-2B~ EM730-0R7-2B terminals are the same as EM730-0R7-3B~ EM730-1R5-3B;

EM730-1R5-2B~ EM730-2R2-2B terminals are the same as EM730-2R2-3B~ EM730-4R0-3B.

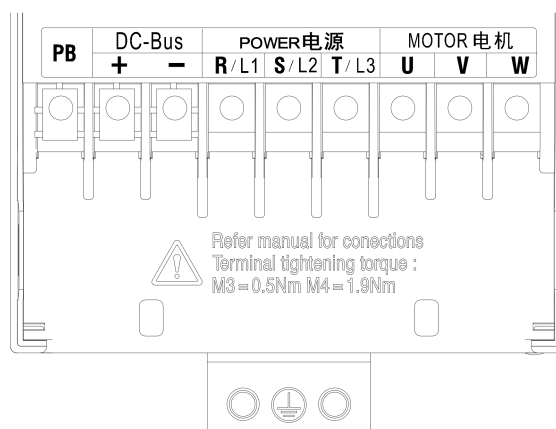

(b) Schematic Diagram of Terminals (EM730-2R2-3B-PV~EM730-4R0-3B-PV)

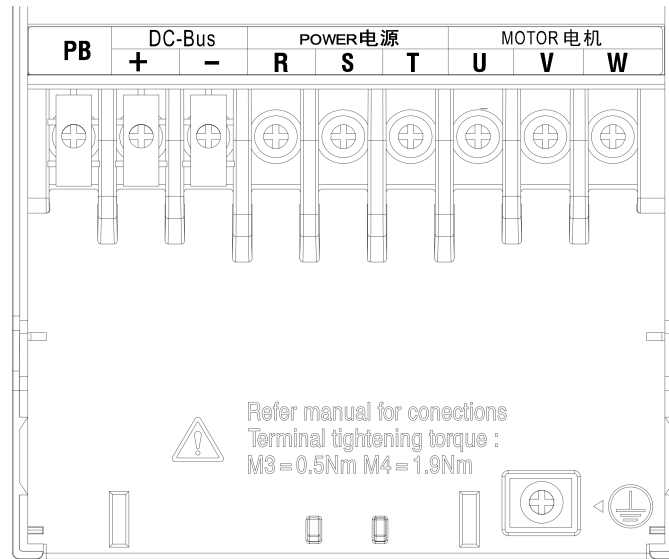

(c) Schematic Diagram of Terminals (EM730-5R5-3B-PV~EM730-022-3B-PV)
(with slight difference in the grounding position)

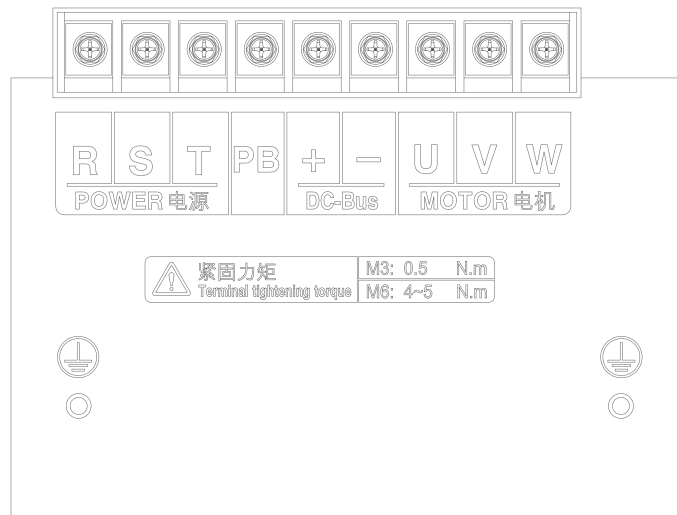

(d) Schematic Diagram of Terminals (EM730-030-3/3B-PV~EM730-037-3/3B-PV)

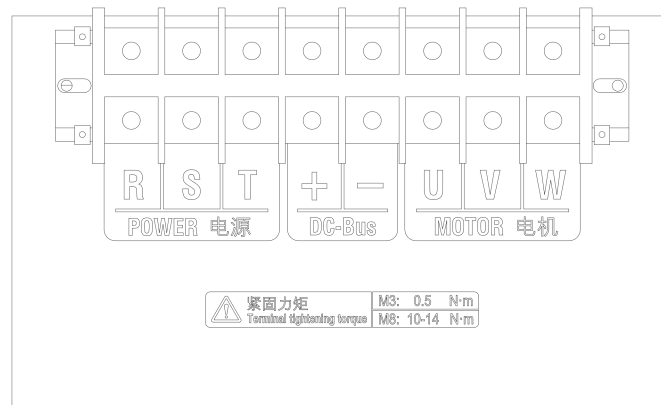

(e) Schematic Diagram of Terminals (EM730-045-3-PV~EM730-110-3-PV)

5.3 wiring

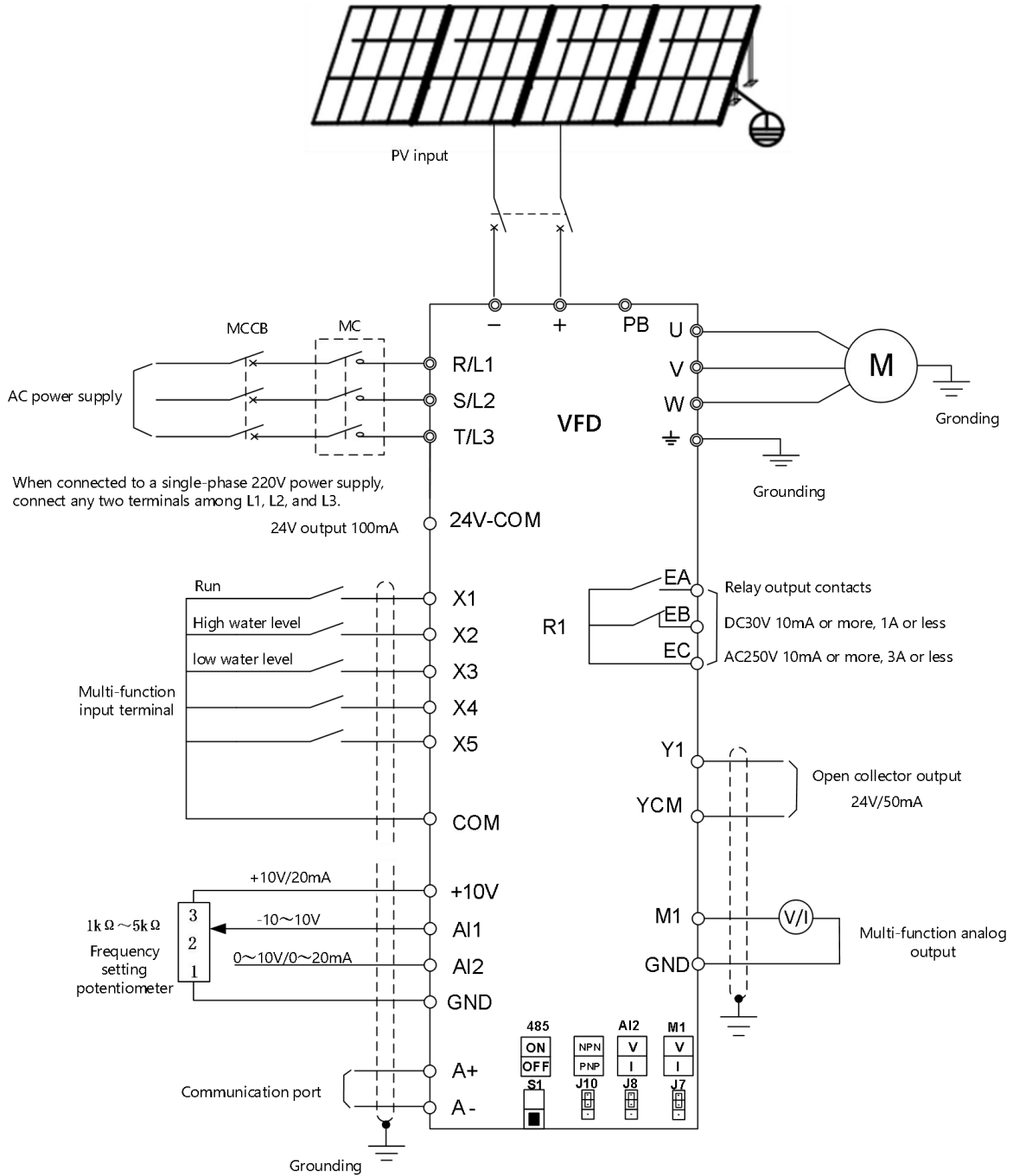

(a) Main circuit terminal wiring

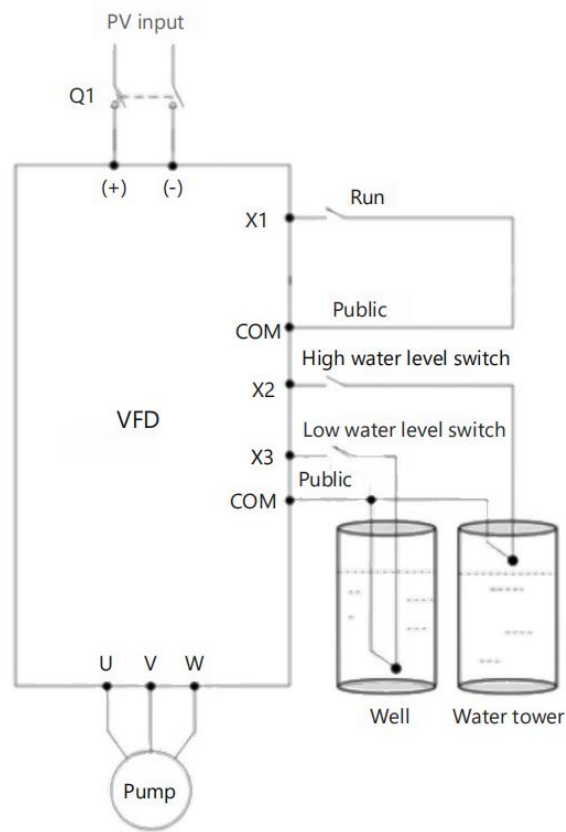

(b) Main circuit terminal wiring

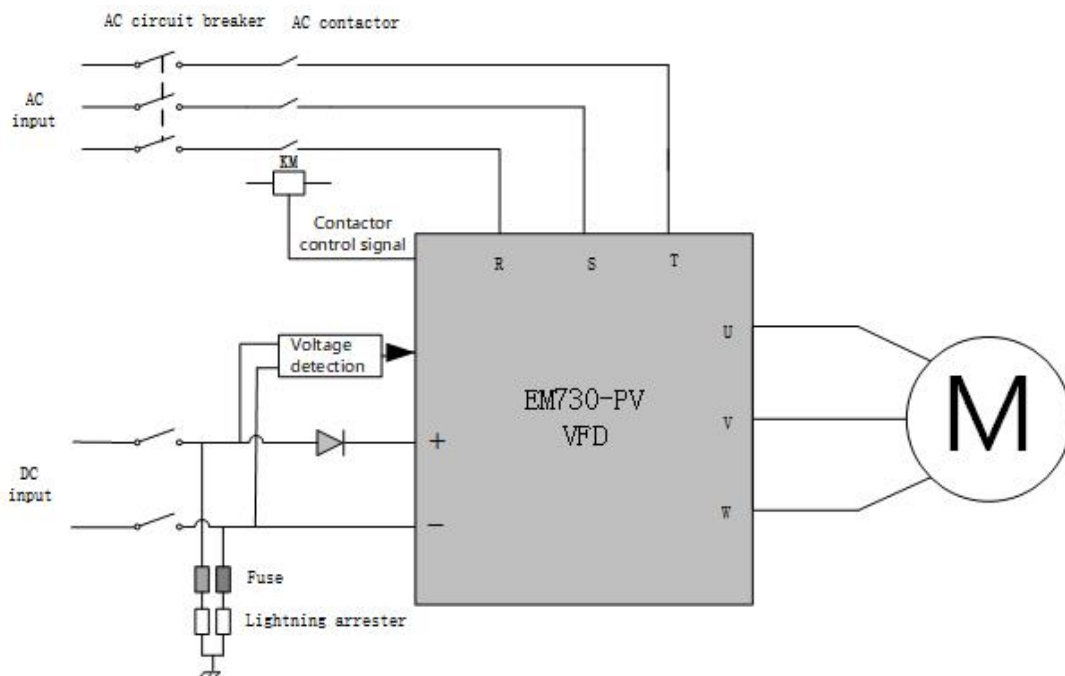

(c) AC/DC switching

Part 6 Product Installation

	Attention
<p>1. When carrying the inverter, hold its bottom. If you hold the panel only, the body may fall to hit your feet.</p> <p>2. Install the inverter on non-flammable boards (e.g. metal). If the inverter is installed on a flammable object, a fire may occur.</p> <p>3. When two or more inverters are installed in one control cabinet, please install a cooling fan and keep the air temperature below 50 °C at the air inlet. Overheating may cause fire and other accidents.</p>	

6.1 Installation site

The installation site should meet the following conditions:

- ① The room is well ventilated.
- ② The ambient temperature should be -10°C to 50°C . When the plastic case is used at the ambient temperature above 40°C , remove the top baffle.
- ③ The controller should be free from high temperature and humidity (less than 90% RH) or rainwater and other liquid droplets.
- ④ Please install the inverter on a fire-retardant object (e.g. metal). Never install it on flammable objects (e.g. wood).
- ⑤ No direct sunlight.
- ⑥ There should be no flammable or corrosive gas and liquid.
- ⑦ There should be no dust, oily dust, floating fibers or metal particles.
- ⑧ The installation foundation should be secured and vibration-free.
- ⑨ Avoid electromagnetic interference and keep the controller away from interference sources.

6.2 Environment temperature

In order to improve the operational reliability, please install the inverter in a well-ventilated place.

When it is used in a closed cabinet, a cooling fan or cooling air conditioner should be installed to keep

the ambient temperature below 50°C.

6.3 Preventive measures

Take protective measures to the inverter during installation to prevent metal fragments or dust generated in drilling and other processes from falling into the inverter. Remove the protection after installation.

6.4 Installation Direction and Space

The EM730-1R5-3B-PV inverters and above are equipped with the cooling fan for forced air cooling. To ensure good cyclic cooling effects, the inverter must be installed in a vertical direction, and sufficient spaces must be reserved between the inverter and adjacent objects or baffles (walls).

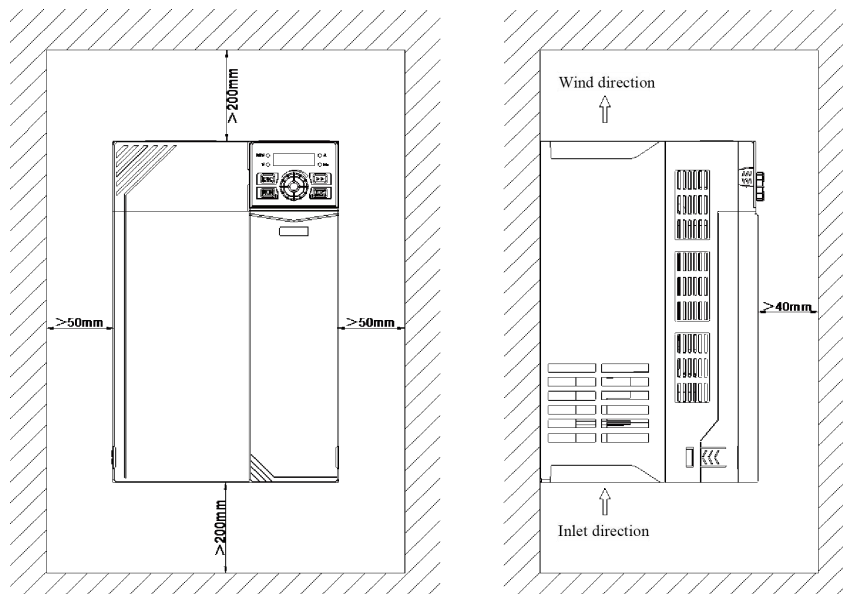

Part 7 Keyboard Operation

7.1 Keyboard Functions

7.1.1 Structure of LED keyboard

The control panel of EM730 series inverter is a pluggable LED keyboard. The LED keyboard has one five-digit LED digital display, four operation buttons, one digital potentiometer, and six status and unit indicators. Users can perform parameter setting, status monitoring and start/stop of the inverter via the keyboard.









Fig. 7-1 LED Keyboard

7.1.2 Functions of keys and indicators on LED keyboard

The functions of the keys and indicators on the LED keyboard are as shown in Table 7-1.

Table 7-1 Functions of Keys and Indicators on LED Keyboard

Key/Indicator	Name	Function
	Right	Select the group number and function number of the currently modified function code. Change the monitoring parameters.
	Back	Go back to the previous menu. Cancel the current parameter modification when the menu mode selection level is enabled from the monitoring level.
	Run	When the keyboard control is enabled, press this key to start the inverter.
	Stop/Reset	When the keyboard control is enabled, press this key to stop the inverter. Reset the protection in use.
	Potentiometer/ Confirm key	Turn it clockwise to select the function code and menu group or increase the parameter value. Increase the currently valid reference digital input data. Turn it counterclockwise to select the function code and menu group or decrease the parameter value. Decrease the currently valid reference digital input data. Click it to enter the lower-level menu. Confirm and save the parameter modification, and enable the function code following the current function code.
	Unit indicator	It is ON when the frequency, current, and voltage are displayed.
	Running direction indicator	This indicator is ON during reverse running. It is OFF during forward running. It is ON when a certain frequency is being monitored or displayed.

7.2.1 Full menu mode (--A--)

In the full menu mode, press the ENTER key  to enter the Level 2 menu and select any function code. Then press the ENTER key to enter the Level 3 menu and view or modify the function code. Except for a few special ones, the function codes needed by general users can be modified.

The entire process from the initial status of power-on to change of the value of the function code F03.28 to 5.28 in the full menu mode is shown in Fig. 7-3.

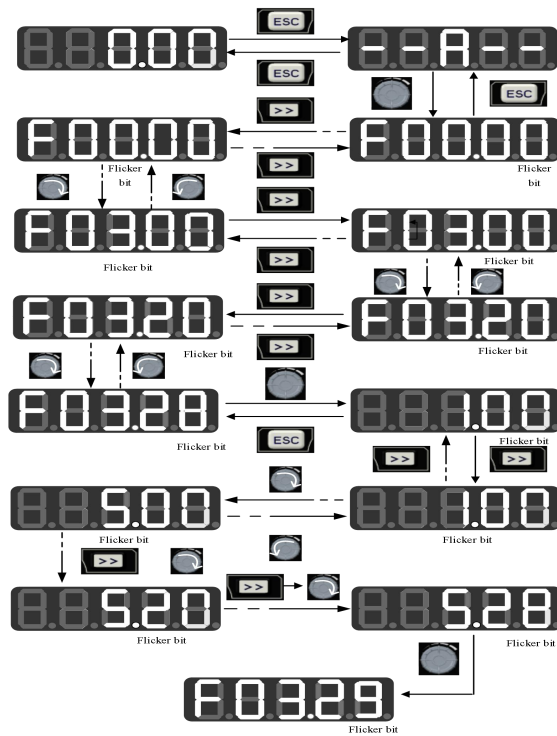



Fig. 7-3 Flowchart from Power-on to F03.28=5.28 Setting

In all menu modes, the user needs to press the ENTER key  to save parameter modifications. Differences after parameter saving are as follows: In the full menu mode, enter the function code following the function code that has been successfully modified. In the user-defined mode, enter the user-defined function code (according to the sequence defined in F11.00-F11.31) following the function code that has been successfully modified. In the non-default mode, enter the non-default function code following the non-default function code that has been successfully modified. In the protection information display mode, enter the protection information function code following the

protection information function code that has been successfully modified. In the version information display mode, enter the serial number function code following the serial number function code has been successfully modified.

In the Level 3 menu, press the ESC key  to abandon parameter modifications.

7.2.2 User-defined mode (--U--)

Enter the F11 group of function codes from the full menu mode. Then the user can arbitrarily set the shortcut for the parameter to be accessed frequently. When F11.00 is enabled for the first time, U00.00 will be displayed by default, meaning that the function code defined by default for F11.00 is F00.00. The lowest cursor bit will flicker. The user can set any function code, similar to the function code selection in the Level 2 menu. After setting, press the ENTER key  to save it and enter the user-defined menu mode to display the set function code.

For example, F11.00 is set to U00.07 and F11.01 to U00.09. F11.00 and F11.01 will be defined as F00.07 and F00.09, respectively. They are distinguished by U and F. U indicates that this function code is user-defined, as shown in Fig. 7-4.

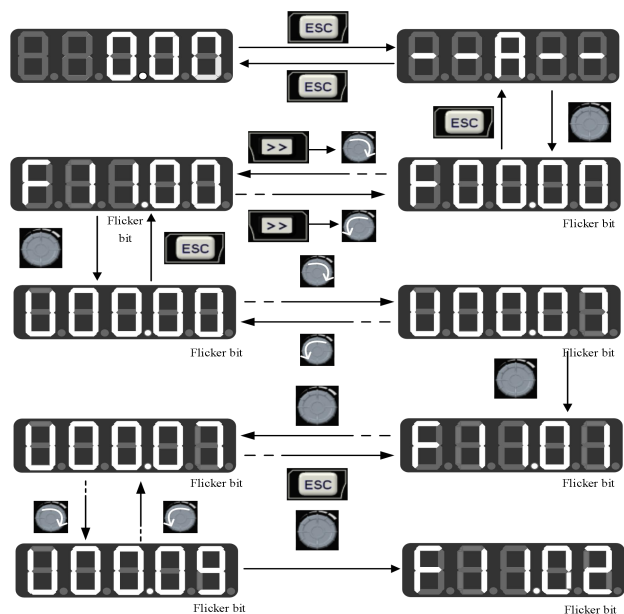





Fig. 7-4 Example of User-defined Mode Setting

In the user-defined mode, press the ENTER key  to enter the Level 2 menu. The Level 2 menu only display 32 user-defined parameters in the F11 group. The user can enter the F11 group from the full menu mode to set these function codes.

After the function codes are defined in the F11 group, enter the user-defined mode. Then we can see F00.07 defined by the first function code F11.00, F00.09 defined by the first function code F11.01, and so on to F11.31, 32 in total. Function code modification in the Level 3 menu is equivalent to that in the full menu mode, and the modification method is also the same.



In the Level 2 menu of the user-defined mode, turn the potentiometer key  on the keyboard, to change the function code defined by F11.00 to that defined by F11.31.

When the right shift key  is pressed in the Level 2 menu, the cursor will not shift. Press the ENTER key  to enter the Level 3 menu. If the displayed function code is modifiable currently, the lowest bit indicated by the cursor will flicker. Parameter modification is the same as that in the Level 3 menu under the full menu mode. After modification, press the ENTER key to confirm and save the parameters and enable next user-defined parameter. Function code modifications in the Level 3 menus under different menu modes have equivalent effects.

7.2.3 Non-default mode (--C--)

In the non-default mode, press the ENTER key to enter the Level 2 menu. The first parameter different from the default settings of the inverter will be displayed, starting from F00.00. When the right shift key  is pressed in the Level 2 menu, the cursor will not shift. If the increment or decrement key on the keyboard is pressed, the function group and function code will not be modified, and the non-default function code following and in front of the current function code will be displayed respectively. If the displayed function code is modifiable currently in the Level 3 menu, the lowest bit indicated by the cursor

will flicker. In this case, parameters can be modified in the Level 3 menu under the full menu mode. After modification, press the ENTER key  to confirm and save the parameters and enable next non-default parameter.

For example, change F00.03 to 1 and F00.07 to 40.00 in the full menu mode, which are not default values. Then enable the non-default mode. F00.03 will be displayed first. When the potentiometer key  on the keyboard is turned clockwise, F00.07 will be displayed; and when the potentiometer key  on the keyboard is turned counterclockwise, F00.03 will be returned, as shown below:

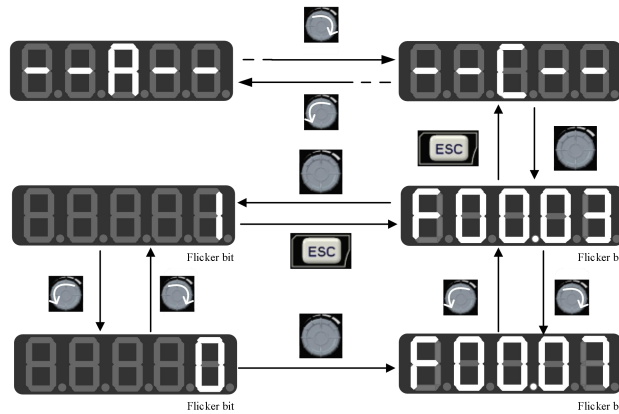





Fig. 7- 5 Function Code Modification in Non-default Mode

7.2.4 Protection information display mode (--E--)

In the protection information display mode, press the ENTER key to enter the Level 2 menu. The Level 2 menu will only display the fault record group under the F19 group, which is conducive to direct viewing of protection record information.

Turn the potentiometer key  on the keyboard in the Level 2 menu under this mode to increase or decrease the function code of the protection group, and the shift key  will be unavailable. In case of protection, you can press the shift key  on the keyboard in the Level 3 menu to switch the display of the protection code, protection output frequency, protection output current, protection bus voltage, and protection operation status.

7.3 Protection Monitoring

When the inverter is in the protection status, you can directly press the right shift key  to switch the current protection type and the output frequency, output current, output voltage, running status and working time during the protection.

7.4 Operation Monitoring





7.4.1 Normal monitoring

In the monitoring status mode 1 of EM730, you can set any function code to be viewed between F12.33 and F12.37. When F12.32=1, the monitoring mode 1 will be enabled. If the Level 0 monitoring menu appears, you can press the right shift key  to switch the monitoring parameters according to the order set for each function code between F12.33 and F12.37. When the inverter changes from the stop status to running status, the monitoring parameter will automatically change from the current value to that indicated by F12.33. When the inverter changes from the running status to stop status, the monitoring parameter will automatically change from the current value to that indicated by F12.34.

7.4.2 Editing Mode

Quick change in the monitoring mode:

When F00.04 is set to "0: digital frequency setting F00.07", turn the potentiometer key  to directly change the offset;

When F00.04 is set to "8: digital potentiometer", turn the potentiometer key  to change the set frequency of F12.42 digital potentiometer. In this case, turn the potentiometer key  to enter the editing mode. The value will change from the second digit of the digital tube by default. The digital tube corresponding to the changed digit will flash. Press the right shift key  to move to next digit on the right. Press the ESC key  to cancel change and return to the original value. Or, press the ENTER key  to confirm the change and exit the editing mode. The indicator will not be flicker. Press the right shift

key  to enable the normal monitoring mode: switch to next monitoring parameter. Fig. 7-6 shows the editing status in the monitoring mode.

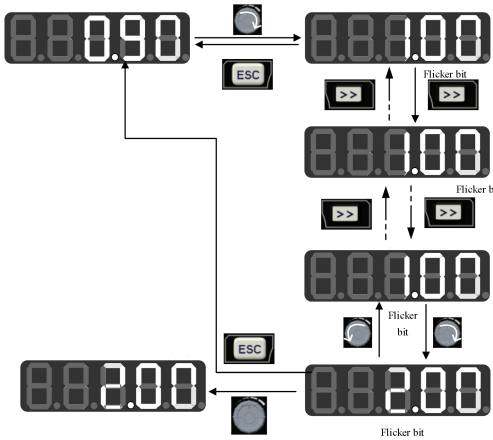



Fig. 7-6 Editing Status in the Monitoring Mode

7.5 Run/Stop

After setting the parameters, press the RUN key  to enable the normal operation of the inverter, and the STOP/RESET key  to stop the inverter.

7.6 Other Warning Prompts

7.6.1 P.-ON prompt

The P.-ON prompt will be displayed after power-on initialization.

7.6.2 P.-OFF prompt

When the voltage drops to 250V (with the soft start disconnected), P-OFF will be displayed, and the keyboard can be operated freely to exit the P.-OFF display and display normal information. In case of no keyboard operation within 5s, P-OFF will be displayed again. After the voltage is restored and the soft start is engaged, P.-ON will be displayed again.

7.6.3 SOFT.E warning

If the soft start is not engaged and the inverter is started, the SOFT.E warning will appear. After the voltage is restore and the soft start is engaged, normal operation will be enabled.

Part 8 Debugging Guide

8.1 Pre-operation check

Please make sure to check the following items before turning on the power.

- ① Check whether the inverter is reliably grounded;
- ② Check whether the wiring is correct and reliable;
- ③ Check whether the selection of AC and DC circuit breakers is correct;
- ④ Check whether the photovoltaic DC input voltage is within the allowable range of the inverter;
- ⑤ Check whether the type, voltage and power of the motor match those of the inverter.

8.2 Trial operation

Close the DC circuit breaker. The inverter will automatically start running after a delay of about 15 seconds, and observe the water output of the water pump. If the water output is normal, the trial run is successful; if the water output is small, swap any two motor wires before running.

8.3 Parameter settings

The inverter runs automatically when powered on by default. If you need to set parameters, you can modify them directly through the keyboard. For some parameters that need to be stopped to modify, you need to set the parameters within 15 seconds after the inverter is powered on. If the inverter is already running after powering on, press the STOP/RESET key to stop it and then enter the parameter setting interface. After completing the parameter setting, turn off the power switch and then turn it on again to put it into operation again.

8.4 Description of single-phase asynchronous motor

8.4.1 Wiring method:

- ① Connect the running capacitor : The output U and V phases of the inverter are connected to the phase line of the single-phase motor

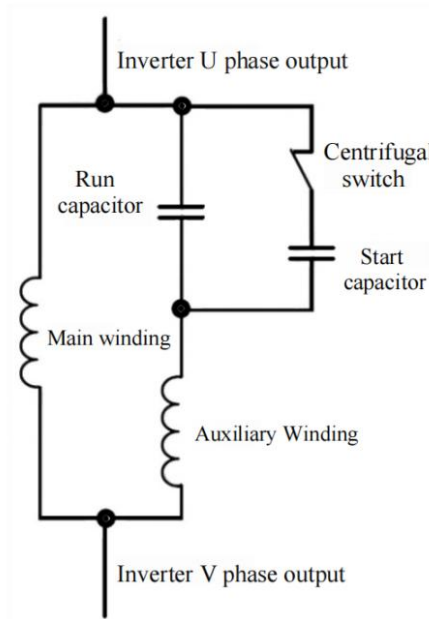

- ② Remove the running capacitor : connect the inverter U phase to one end of the main winding, the V phase to one end of the auxiliary winding, and short-circuit the other ends of the main and auxiliary windings together and connect them to the inverter W phase.

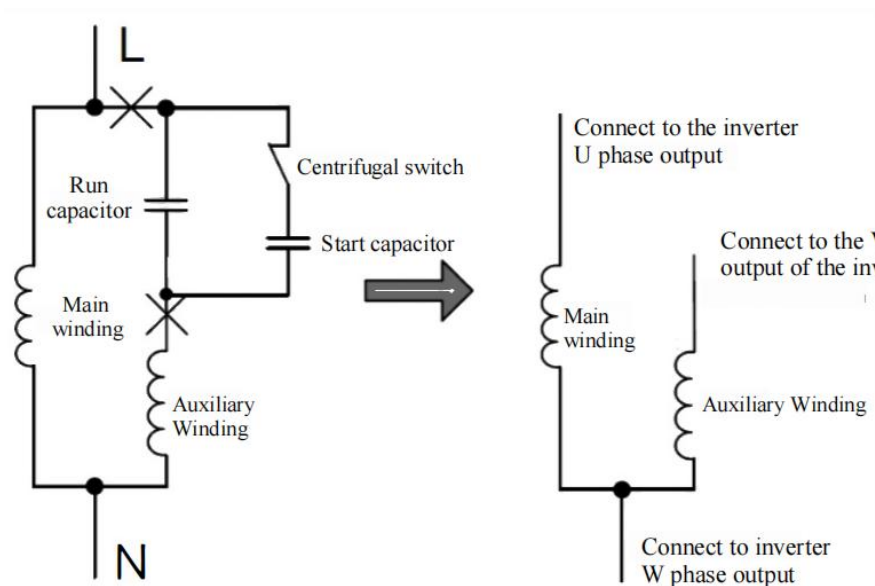

8.4.2 Parameter settings:

- ① Connect running capacitor : Select single-phase motor as the motor type and connect running capacitor (F01.00=6). Since the running capacitor is set at 50 Hz, when the frequency is low, the secondary winding capacitive reactance is large, resulting in a small current. Therefore, it cannot be started when the frequency is set too low. Generally, it needs to be higher than 30 Hz, or a large capacitor that can run for a long time is connected to the secondary winding for low-frequency starting. If the motor vibrates or the current is large, it can be set to multi-point broken line VF (F05.00=1), and the values of F05.01~F05.06 can be adjusted according to the motor operation : reduce the voltage when the motor current is too large, and increase the voltage when the motor cannot start.
- ② Remove the running capacitor : Select the single-phase motor with running capacitor (F01.00=5) as the motor type. Since the impedance of the main and auxiliary windings are different, if the main and auxiliary windings output the same voltage, the motor may vibrate. If the motor vibrates, adjust the main and auxiliary winding voltage ratio (F51.42) to reduce the vibration.
- ③ Output voltage gain setting :

If the motor current is large or jitter occurs at the maximum frequency, the maximum output voltage can be reduced by adjusting the output voltage gain (F51.43) .

8.5 Function parameter list

The relevant function codes are as follows, which need to be used in conjunction with the complete function parameters in the EM730 User Guide.

Function code	Function code name	Parameter Description	unit	Factory value	property
F00	Basic function parameter group				
F00.02	Command source selection	0: Keyboard control 1: Terminal control 2: Communication control		0	○
F00.14	Acceleration time 1	0.00~650.00	s	5.00	●
F00.15	Deceleration time 1	0.00~650.00	s	0.50	●
F01	Motor 1 parameter group				
F01.00	Motor Type Selection	0: Ordinary asynchronous motor 1: Variable frequency asynchronous motor 2: Permanent magnet synchronous motor 3 : Reserved 4 : Reserved 5 : Single-phase asynchronous motor (without running capacitor) 6 : Single-phase asynchronous motor (connected to running capacitor)		0	○
F02	Input terminal function group				
F02.00	X1 digital input function selection	0: No function 1: Run terminal RUN 10: Fault reset 96: Low water level signal 97: Full water level signal		1	○
F02.01	X2 digital input function selection			96	○
F02.02	X3 digital input function selection			97	○
F07	Fault protection group				
F07.06	Bus voltage control selection	Units: Instantaneous stop without stopping function selection 0: Invalid 1: Deceleration 2: Deceleration stop Tens: Overvoltage stall function selection 0: Invalid 1: Valid		00	○
F07.14	Failure retry times	0~20, 0: Disable fault retry		0	○
F07.16	Failure retry interval	0.1~3 600 .0	s	0.50	●
F18	Monitoring Parameter Group				
F18.00	Output frequency	0.00~Upper frequency limit	Hz	XXX	×
F18.01	Setting frequency	0.00~maximum frequency F00.16	Hz	XXX	×
F18.06	Output Current	0.00~650.00	A	XXX	×
F18.08	Output voltage	0.0~690.0	V	XXX	×
F18.09	DC bus voltage	0~1200	V	XXX	×
F19	Fault Record Group				
F19.00	The most recent fault type	0 : No fault E01 : Output short circuit protection E02 : Instantaneous overcurrent E03 : Instantaneous overvoltage E04 : Steady-state overcurrent E05 : Steady-state overvoltage E06 : Steady-state undervoltage E07 : Input phase loss E08 : Output phase loss		0	×

EM730 Solar Pump Inverter User Manual V1.0

		E14 : External fault E16 : Communication abnormality E21 : PID feedback disconnection EtSLP : Water shortage dormancy FuSLP : Full water storage tank sleep LvSLP : Weak light sleep drSLP : Dry running sleep			
F19.01	Output frequency when fault occurs	0.00~Upper frequency limit	Hz	0.00	×
F19.02	Output current during fault	0.00~650.00	A	0.00	×
F19.03	Bus voltage during fault	0~1200	V	0	×
F19.04	Operation status during failure	0: Not running 1: Forward acceleration 2: Reverse acceleration		0	×
F19.05	Working time during failure		h	0	×

8.6 Photovoltaic water pump special function parameter description

Function code	name	Parameter Detailed Description	Default value	property
F51.00	Solar pump mode	0: General inverter mode 1: CVT mode 2: PID regulation MPPT mode 4: Frequency disturbance regulation MPPT mode 0 means the photovoltaic water pump mode is invalid and it is a general model; 1 means that the fixed voltage setting method is adopted , and the reference voltage is the digital reference voltage of F51.01 , which is a fixed value; 2 is the MPPT mode of reference voltage disturbance regulation . A value of 4 indicates the MPPT mode using frequency disturbance regulation.	0	○
F51.01	Reference voltage Digital given	0~F51.02 V When F51.00 is set to 1, the reference voltage value is given by this function code.	600 V /260 V	●
F51.02	Reference voltage Maximum	0~6000 V The maximum value of the reference voltage that can be set	750 V /400 V	○
F51.03	Minimum output frequency allowed	0.00~50.00 Hz When in photovoltaic water pump mode, when the output frequency is lower than this value, after the delay time set by F51.12, the inverter reports a weak light sleep fault.	10.00 Hz	●
F51.04	Water shortage dormancy delay	0.0~3600.0 S When the low water level signal of the input terminal is valid (No. 96), after the delay time set by this function code, the water shortage alarm (EtSLP) is reported and the system goes into sleep mode. In the case of non-continuous operation, the delay timer will be automatically reset.	5.0S	●
F51.05	Water shortage Wake-up delay	0.0~3600.0 S When the input terminal low water level signal is invalid (No. 96), after the delay time set by this function code, the water shortage alarm (EtSLP) is invalid and re-enters the running state. In the case of non-continuous, the delay timer will be automatically reset.	20.0S	●
F51.06	Reservoir full of water Sleep delay	0.0~3600.0 S When the full water level signal of the input terminal is valid (No. 97), after the delay time set by this function code, the water tank full water alarm (FuSLP) is reported and the system goes into sleep mode. In the case of non-continuous operation, the delay timer will be automatically reset to zero.	5.0S	●
F51.07	Reservoir full	0.0~3600.0 S	20.0S	●

EM730 Solar Pump Inverter User Manual V1.0

	of water Wake-up delay	When the full water level signal of the input terminal is invalid (No. 97), after the delay time set by this function code, the full water alarm of the reservoir (FuSLP) is invalid and the system re-enters the running state. In the case of non-continuous, the delay timer will be automatically reset.		
F51.08	Dry run detection frequency	0.00~Fmax Hz This function code sets the detection frequency during dry-run detection.	45.00 Hz	●
F51.09	Dry running detection current	0.0~100.0% (100% corresponds to the rated current of the motor) This function code sets the detection current during dry-run detection.	30.0%	●
F51.10	Dry run detection Delay time	0.0~3600.0 S This function code sets the delay current during dry-run detection. When the output frequency is greater than the dry-run detection frequency set by F51.08, the output current is less than the dry-run detection current set by F51.09, and the duration is greater than the dry-run delay time set by F51.10, a dry-run alarm (drSLP) is issued and the system goes into sleep mode. In non-continuous situations, the delay timer will be automatically cleared.	20.0S	●
F51.11	Dry-run detection alarm reset time	0~600 Min After the dry-run alarm is enabled, the dry-run alarm (drSLP) becomes invalid after the delay time set by this function code, and the system re-enters the running state. In the case of non-continuous operation, the delay timer will be automatically reset to zero.	1 Min	●
F51.12	Weak light sleep delay time	0.0~3600.0 S When the output frequency is less than or equal to the value set by F51.03, the delay timing starts. After this state continues for the weak light sleep delay time, the weak light alarm (LvSLP) is reported and the system goes to sleep. In the case of non-continuity, the delay timing will be automatically cleared.	100.0 S	●
F51.13	Weak light wake-up delay time	0.0~3600.0 S In the weak light alarm, when the photovoltaic input voltage is greater than the value set by F51.16, the delay timing starts. After this state continues for the weak light wake-up delay time, the weak light alarm (LvSLP) is cleared and the running state is re-entered.	1 00.0 S	●
F51.14	Weak light voltage setting	0~750 V When the PV input voltage is lower than the set voltage value, the delay timing starts. The PV input voltage continues to be lower than the set voltage value time (F51.15 function code setting). After reaching the time, the weak light alarm (LvSLP) is reported and sleep is performed.	380 V model: 350 220 V model: 180	●
F51.15	Weak light voltage detection time	20 ms~3000 ms	20ms	●
F51.16	Light recovery voltage	0~1200 In the weak light sleep state, if the photovoltaic input voltage is greater than this set value and the delay time set by F51.13 has passed, the weak light alarm (LvSLP) is cleared and the system re-enters the running state.	380 V model: 660 220 V model: 3 2 0	●
F51.17	Reference voltage initial value adjustment	0~200 V The maximum power tracking starts with a disturbance of the reference voltage initial value. Initial reference voltage = PV input voltage - F51.17	50 V	●
F51.18	Maximum tracking reference	F51.19~F51.02 reference voltage for tracking . The factory value is determined by the model:	750 V	●

EM730 Solar Pump Inverter User Manual V1.0

	voltage	380 V model: 750 V 220 V model: 400 V		
F51.19	Minimum tracking reference voltage coefficient	0.00~1.00 This function code can be used to set the minimum voltage reference for maximum power tracking. Maximum Power Tracking Minimum Voltage Reference = Photovoltaic panel open circuit voltage * F51.19. The maximum power tracking voltage will track within the range of the minimum voltage reference~ F51.18, F51.23 must be greater than the minimum voltage reference. The smaller the difference between the two, the narrower the tracking range and the faster the tracking. However, it is imperative that the voltage point of the normal maximum power falls within this range. F51.18 and F51.19 must be adjusted appropriately according to the on-site conditions. The current minimum reference voltage can be checked through F51.26.	0.70	●
F51.20	Automatically adjust reference voltage time	0.0~10.0 S (0.0 is invalid) When F51.20 is set to 0.0, the automatic adjustment of reference voltage is invalid. The reference voltage limit is automatically adjusted once every time interval set by F51.20 .	0.5 S	●
F51.21	Allowable output frequency fluctuation range	0.30 Hz~10.00 Hz When the output frequency fluctuation is less than the function code value, the reference voltage is not adjusted, but when the output frequency fluctuation range is greater than the function code value, the reference voltage is increased.	2.00 Hz	●
F51.22	Reference voltage adjustment amplitude	0~300 V, adjust the reference voltage according to the value set by this function code.	5 V	×
F51.23	Initial reference voltage for PI regulation	0~6000 V Initial reference voltage for PI regulation = Current PV voltage – F51.17		
F51.24	Current PV voltage display	0~6000 V Displays the current PV input voltage		×
F51.25	PV reference voltage display	0~6000 V Display the current reference voltage value		×
F51.26	Minimum tracking reference voltage display	0~6000 V Displays the minimum reference voltage for maximum power tracking		×
F51.27	reserve			
F51.28	reserve			
F51.29	Rated flow of water pump	0.0~1000.0 m ³ /h The flow rate of the pump at rated frequency and rated head Q_N Unit: cubic meter/hour	6.0 m ³ /h	●
F51.30	Rated head of water pump	0.0~500.0 m The head of the pump at rated frequency and rated flow rate is H_N Unit: meter	24.0 m	●
F51.31	Pump total flow reset	0: Do not reset 1: Reset This function code to 1 can reset the total flow of the pump. F51.32 and F51.33 will be cleared and restarted. After the reset is completed, function code F51.29 will automatically become 0.	0	●
F51.32	Current flow of the pump	0.0~2000.0 m ³ /h $Q = Q_N * F^* / F_N$ Unit: cubic meter/hour		×
F51.33	Current head of water pump	0.0~2000.0 m $H = 0.9 H_N * (F / F_N)^2$		×

EM730 Solar Pump Inverter User Manual V1.0

		Unit: meter		
F51.34	Pump total flow high	0~65535 m ³ This function code displays the upper 16 bits of the total flow of the pump. Unit: cubic meter.		×
F51.35	Total pump flow rate low	0.0~6553.5 m ³ This function code displays the lower 16 bits of the total flow of the pump. Total pump flow = F51.32 * 6553.5 + F51.33 Unit: cubic meter.		×
F51.36	Power failure restart selection enable	0: Invalid 1: Valid	1	●
F51.37	Power failure restart delay time	0.0~600.0 S	15.0 S	●
F51.38	Kp	0.00~100.00 PID proportional adjustment parameters	10.00	●
F51.39	Ki	0.00~100.00 PID integral adjustment parameters	0.50	×
F51.40	Kd	0.00~100.00 PID differential adjustment parameters	0.00	×
F51.41	Rapid frequency reduction	0.00~50.00 Hz When the photovoltaic input voltage is lower than (F51.14+50 V), the output frequency will be reduced by the value set by this function code every 1ms.	0.50 Hz	×
F51.42	Main and auxiliary winding voltage ratio	1.00~5.00 This function code sets the voltage ratio of the main winding and the auxiliary winding. When the motor shakes, adjusting this function code appropriately can reduce the motor shaking.	1.00	●
F51.43	Output voltage gain	0.00~1.00 This function sets the output voltage gain. When the motor current is too large, the value of this function code can be appropriately reduced.	1.00	●
F51.44	MPPT step time	0.01~10.00 MPPT dynamically adjusts the time period of output frequency	0.05s	●
F51.45	MPPT frequency adjustment	0.00~5.00 MPPT increases the reference value of the frequency when dynamically adjusting the output frequency. When the output frequency needs to be increased, the frequency increases by the value set by this function code for each time period set by F51.44.	0.05 Hz	●
F51.46	Voltage regulation ratio in mode 4	1~100 When dynamically adjusting the output frequency, the photovoltaic input voltage will fluctuate. This function code sets the ratio of the difference of normal voltage fluctuation to the reference voltage of F51.25. When the voltage fluctuation difference is greater than this function code, the frequency will not be increased.	10	●
F51.47	Fast frequency reduction detection times	0~50 If the photovoltaic input voltage decreases continuously within the N MPPT cycles set by this function code, the frequency reduction process will be performed quickly. N is the value set by this function code.	3	●
F51.48	Fast frequency reduction gain	0~100 Each time the output frequency needs to be quickly reduced, the output frequency is reduced by N times the adjustment frequency set by F51.45. N is the value set by this function code.	2 0	●

8.7 Notes

- ① After restoring the factory values, you need to set F51.00 to 1, 2 or 4 to use the photovoltaic water pump special function normally.
- ② If you want the water pump to run automatically after power failure and then power on, please set the command source F00.02 = 0 keyboard control. Do not set the command source to terminal control.
- ③ For the timing problem of meeting multiple alarm conditions at the same time, such as water shortage alarm, full water alarm, weak light alarm, dry run alarm, when each condition is met at the same time, each will start delay timing, which is not related. When a certain alarm delay time is reached, the alarm is valid and dormant. The other 3 alarm delay timings will be maintained. After the alarm is reset and restored to normal, if the other 3 alarm conditions are still met, the last timing will continue, and so on. If an alarm condition is not met in the middle, the alarm delay timing will be reset.

8.8 Quick debugging solution

1. Set the corresponding inverter and motor parameters according to the inverter nameplate and motor nameplate.
2. Set the photovoltaic water pump parameter group

In photovoltaic water pump control, we have 3 different photovoltaic water pump modes:

F51.00 = 1 CVT mode

F51.00 = 2 PID-regulated MPPT mode

F51.00 = 4 frequency disturbance-regulated MPPT mode

2.1 Set F51.00 = 1.

① Introduction to working logic

In this mode, function code F51.01 is used as the given value of the PID regulator, the current input voltage is used as the feedback of the PID regulator, and the output of the PID regulator is used as the increment of the given frequency of the inverter. The execution cycle of the PID module is set by function code F51.44.

During the startup phase, the inverter starts running at a fixed motor rated frequency, and the input voltage decreases accordingly. When the voltage decreases by the value set by F51.17, that is, the input voltage is lower than the initial reference voltage of F51.23 PI regulation, it enters the dynamic adjustment phase.

In the dynamic adjustment stage, the given value of the PID regulator is a fixed value, which is displayed by function code F51.25 and modified by function code F51.01. The user can modify it manually. The feedback of the PID regulator is the current photovoltaic input voltage, which is displayed by function code F51.24.

② Set digital given reference voltage F51.01

If the user uses this mode, a suitable reference voltage needs to be set.

If the reference voltage is set too low, the photovoltaic input voltage and the inverter output frequency will oscillate significantly. At this time, the F51.01 digital given reference voltage can be appropriately increased until there is no obvious oscillation.

If the reference voltage is set too high, the inverter output frequency is relatively stable in intuitive performance. The F51.01 digital given reference voltage can be appropriately reduced to obtain a higher output frequency.

③ PID parameter adjustment

The default parameters can basically meet most conditions.

If you want to increase the response speed, you can increase Kp F51.38 appropriately. However, a larger Kp will cause a sharp drop in input voltage during the startup process, resulting in a false alarm of weak light sleep failure. Reducing Kp can get a more stable output frequency.

Increasing Kif51.39 can eliminate steady-state errors and suppress fluctuations in output frequency and photovoltaic input voltage to a certain extent.

④ F51.41 Rapidly reduce frequency

During operation, it is inevitable that the photovoltaic input voltage will drop rapidly in an instant. At this time, if the PID regulator cannot respond quickly to reduce the output frequency, a weak light fault may easily occur.

At this time, you can set the function code F51.41. When the input voltage is close to the weak light sleep voltage F51.14, generally the difference is within 50V, the output frequency of the inverter will decrease rapidly, and the pump-up voltage of the motor deceleration will increase the photovoltaic input voltage to maintain the normal operation of the system. The frequency reduction every 1 ms is set by F51.41.

This function is only valid when F51.00 = 1 or 2

3. Set F51.00 = 2.

① Introduction to working logic

In this mode, function code F51.25 displays the given value of the PID regulator, the current input voltage is used as the feedback of the PID regulator, and the output of the PID regulator is used as the increment of the given frequency of the inverter. The execution cycle of the PID module is set by function code F51.44.

During the startup phase, the inverter starts running at a fixed motor rated frequency, and the input voltage decreases accordingly. When the voltage decreases by the value set by F51.17, that is, the input voltage is lower than the initial reference voltage of F51.23 PI regulation, it enters the dynamic adjustment phase.

In the dynamic adjustment stage, the given reference voltage of the PID regulator is displayed by function code F51.25. The system adjusts the given reference voltage of the PID according to the fluctuation of the output frequency. The feedback of the PID regulator is the current photovoltaic input voltage, which is displayed by function code F51.24.

② PID given voltage automatic adjustment

PID The given voltage of the regulator is automatically adjusted based on the initial reference voltage of F51.23. It is automatically adjusted according to the time period set by F51.20 S. The voltage amplitude of each adjustment is set by function code F51.22 .

When the output frequency fluctuates greatly, and the frequency fluctuation is greater than the range set by F51.21, the given voltage is automatically increased. When the output frequency has no fluctuation or fluctuates slightly, and is less than the value set by F51.45, the given voltage is automatically reduced to obtain a higher output frequency.

③ PID parameter adjustment

The default parameters can basically meet most conditions.

If you want to increase the response speed, you can increase Kp F51.38 appropriately . However, a larger Kp will easily cause a sharp drop in input voltage during the startup process, resulting in a false alarm of weak light sleep failure. Reducing Kp can get a more stable output frequency.

Increasing Ki F51.39 can eliminate steady-state errors and suppress fluctuations in output frequency and photovoltaic input voltage to a certain extent .

④ F51.41 Rapidly reduce frequency

During operation, it is inevitable that the photovoltaic input voltage will drop rapidly in an instant. At this time, if the PID regulator cannot respond quickly to reduce the output frequency, a weak light fault may easily occur.

At this time, you can set the function code F51.41. When the input voltage is close to the weak light sleep voltage F51.14, generally the difference is within 50V, the output frequency of the inverter will decrease rapidly, and the pump-up voltage of the motor deceleration will increase the photovoltaic input voltage to maintain the normal operation of the system. The frequency reduction every 1ms is set by F51.41.

This function is only valid when F51.00 = 1 or 2

4. Set F51 . 00 = 4.

① Set F51.14 and F51.16 according to the actual output voltage of the photovoltaic panel

720V in the morning when not running , and the voltage is about 680V after running, then you can set F51.14 = 580V, F51.16 = 700V.

When the input voltage is less than (F51.14 + 20V That is, when the voltage is 600V), after a delay of 3 ms, the output frequency is reduced to 1 Hz and the output frequency is readjusted after 1s.

If a weak light alarm occurs and the F51.24 input voltage shows about 700V (a higher voltage when not running), you can increase F51.15 appropriately.

If the inverter is completely powered off instantly, you need to increase the value of F51.14,

reduce the value of F51.15, reduce the deceleration time (F00.15), set F04.19 = 1 for free stop.

Adjust F51.48.

Taking the single-phase camera model as an example, if the photovoltaic input voltage is 400V when not running in the morning, and the voltage is about 360V after running, you can set F51.14 = 280V, F51.16 = 390V.

When the input voltage is less than (F51.14 + 20V That is, 300V), after a delay of 3 ms, the output frequency is reduced to 1 Hz, and the output frequency is readjusted after 1s.

If a weak light alarm occurs and the input voltage of F51.24 is displayed as about 400V (a higher voltage when not in operation), F51.15 can be appropriately increased.

If the inverter is completely powered off instantly, you need to increase the value of F51.14, reduce the value of F51.15, reduce the deceleration time (F00.15), set F04.19 = 1 for free stop. Adjust F51.48.

The above F51 group parameters are all modified during operation and adjusted according to actual conditions.

② Setting F51.46

During operation, if the output frequency is stable and F51.24 photovoltaic input voltage is stable without fluctuation or with very small fluctuation, you can check the value of F18.55 function code and set F51.46 to a value slightly larger than F18.55. Then observe the output frequency and F51.22 photovoltaic input voltage.

If it is still in a relatively stable state and the output frequency rises significantly, F51.46 can be increased again .

If the output frequency or F51.24 PV input voltage starts to fluctuate or the fluctuation

increases, please reduce the value of F51.46 .

If the output frequency and F51.24 PV input voltage do not change significantly, and the output frequency does not rise significantly after a period of time, please restore F51.46 to the previous setting value.

③ Setting F51.48

During normal operation, the lighting conditions remain unchanged and there is no obvious cloud cover. Observe the output frequency and F51.24 photovoltaic input voltage.

If the frequency fluctuates greatly, the value of this function code can be reduced. After the reduction, it is still necessary to observe that the output frequency decreases when the clouds cover the sun for a moment. If F51.24 fluctuates too much, the light is weak, or the inverter is completely powered off, the value of F51.48 cannot be reduced or the value of F51.48 still needs to be increased. At the same time, check the function code F00.15 deceleration time and F04.19 stop mode. The deceleration time can be reduced and the stop mode can be changed to free stop (F04.19 = 1).

Increasing the value of F51.48 will lead to an increase in the jitter of the output frequency when the photovoltaic input power does not meet the conditions for the motor to operate at the rated frequency. The user needs to set it reasonably.

Part 9 Protection/Warning Solutions

9.1 Protection content

When the inverter is in the abnormal status, the digital tube display will show the corresponding protection code and its parameters, the protection relay and protection output terminal will work, and the inverter will stop the output. In case of protection, the motor will stop rotating normally or slow down until it is stopped. The protection contents and solutions of the EM730 series inverter are shown in Table 9-1.

Table 9-1 Protection Contents and Solutions of EM730 Series Inverter

Protection code	Protection Type	Protection Cause	Protection Solution
E01	Short circuit protection	<ol style="list-style-type: none"> 1. Short circuit to the ground. 2. Inter-phase short circuit 3. Short circuit of the external braking resistor. 4. The acceleration and deceleration time is too short. 5. The inverter module is damaged. 6. There is excessive on-site interference. 	<ol style="list-style-type: none"> 1. Check the wiring for short circuits. 2. Properly increase the acceleration and deceleration time. 3. Investigate the cause and reset the controller after implementing the corresponding solutions. 4. Seek technical support.
E02	Instantaneous overcurrent	<ol style="list-style-type: none"> 1. The acceleration and deceleration time is too short. 2. In the V/F drive mode, the V/F curve setting is unreasonable. 3. The motor is running during startup. 4. The motor used is beyond the capacity of the inverter or the load is too heavy. 5. Motor parameters are not suitable and need to be identified. 6. The phases on the output side of the inverter are short-circuited. 7. The inverter is damaged. 	<ol style="list-style-type: none"> 1. Increase the acceleration and deceleration time. 2. Reasonably set the V/F curve. 3. Enable speed tracking or start DC braking. 4. Use the appropriate motor or inverter. 5. Identify the motor parameters. 6. Check the wiring for short circuits. 7. Seek technical support.
E04	Steady-state overcurrent	The same as E02	The same as E02
E05	Overvoltage	<ol style="list-style-type: none"> 1. The deceleration time is too short, and the motor has too much regenerated energy. 2. The braking unit or braking resistor forms an open circuit. 3. The braking unit or braking resistor does not match. 4. The power voltage is too high. 5. The energy consumption braking function is not enabled 	<ol style="list-style-type: none"> 1. Increase the deceleration time. 2. Check the wiring of the braking unit and braking resistor. 3. Use a suitable braking unit/braking resistor. 4. Reduce the power voltage to the specified range. 5. For the model of the built-in braking unit, set F15.30 to 1, and enable the energy consumption braking.

EM730 Solar Pump Inverter User Manual V1.0

Protection code	Protection Type	Protection Cause	Protection Solution
E06	Undervoltage	<ol style="list-style-type: none"> 1. The input power supply is subject to phase loss. 2. The terminals of the input power supply are loose. 3. The voltage of the input power supply drops too much. 4. The switch contacts of the input power supply are aging. 	<ol style="list-style-type: none"> 1. Check the input power supply and wiring. 2. Tighten the screws of input terminals. 3. Check the air circuit breaker and contactor.
E07	Input phase loss	<ol style="list-style-type: none"> 1. The input power supply is subject to phase loss. 2. The input power supply fluctuates greatly. 	<ol style="list-style-type: none"> 1. Check the input power supply. 2. Check the wiring of the input power supply. 3. Check whether the terminal is loose 4. Use a voltage regulator on the input side.
E08	Output phase loss	<ol style="list-style-type: none"> 1. The output terminals U, V and W have phase losses. 	<ol style="list-style-type: none"> 1. Check the connection between the inverter and motor. 2. Check whether the output terminal is loose. 3. Check whether the motor winding is disconnected.
E09	Inverter overload	<ol style="list-style-type: none"> 1. The acceleration and deceleration time is too short. 2. In the V/F drive mode, the V/F curve setting is unreasonable. 3. The load is too heavy. 4. The braking time is too long, the braking intensity is too high, or DC braking is enabled repeatedly. 	<ol style="list-style-type: none"> 1. Increase the acceleration and deceleration time. 2. Reasonably set the V/F curve. 3. Use the inverter that matches the load. 4. Reduce the braking time and braking intensity. Do not enable DC braking repeatedly.
E10	Inverter overheat	<ol style="list-style-type: none"> 1. The ambient temperature is too high. 2. The inverter is subject to poor ventilation. 3. The cooling fan fails. 	<ol style="list-style-type: none"> 1. The operating environment of the inverter should meet the specifications. 2. Improve the ventilation environment and check whether the air duct is blocked. 3. Replace the cooling fan.
E11	Parameter setting conflict	<ol style="list-style-type: none"> 1. There is a logic conflict in parameter settings. 	<ol style="list-style-type: none"> 1. Check whether parameters set is illogical before the protection.
E13	Motor overload	<ol style="list-style-type: none"> 1. The acceleration and deceleration time is too short. 2. In the V/F drive mode, the V/F curve setting is unreasonable. 3. The load is too heavy. 	<ol style="list-style-type: none"> 1. Increase the acceleration and deceleration time. 2. Reasonably set the V/F curve. 3. Use a motor matching the load.
E14	External protection	<ol style="list-style-type: none"> 1. The protection terminal of the external device acts. 	<ol style="list-style-type: none"> 1. Check the external device.
E15	Inverter memory protection	<ol style="list-style-type: none"> 1. Interference results in memory reading and writing errors. 2. The internal memory of the controller is read and written repeatedly, causing damage to the memory. 	<ol style="list-style-type: none"> 1. Press the STOP/RESET key to reset the controller and try again. 2. For the parameters (e.g. frequency setting) to be modified frequently, set F10.56 to 11 after debugging.
E16	Communication error	<ol style="list-style-type: none"> 1. Communication timeout is enabled in the discontinuous communication system. 2. Communication is disconnected. 	<ol style="list-style-type: none"> 1. F10.03 is set to 0.0 in the discontinuous communication system. 2. Adjust the F10.03 communication timeout. 3. Check whether the communication cable is disconnected.
E17	Abnormality of inverter temperature sensor	<p>The inverter temperature sensor is disconnected or short-circuited.</p>	<ol style="list-style-type: none"> 1. Check whether the inverter temperature sensor is connected properly. 2. Seek technical support.

EM730 Solar Pump Inverter User Manual V1.0

Protection code	Protection Type	Protection Cause	Protection Solution
E18	The soft start relay is not engaged.	<ol style="list-style-type: none"> 1. The power supply fails during operation. 2. The input power supply is subject to phase loss. 3. The terminals of the input power supply are loose. 4. The voltage of the input power supply drops too much. 5. The switch contacts of the input power supply are aging. 	<ol style="list-style-type: none"> 1. Stop the inverter before power-off, or directly reset the protection. 2. Check the input power supply and wiring. 3. Tighten the screws of input terminals. 4. Check the air circuit breaker and contactor.
E19	Error of current detection circuit	The detection circuit of the drive board or control board is damaged.	<ol style="list-style-type: none"> 1. Seek technical support.
E20	Stall protection	<ol style="list-style-type: none"> 1. The deceleration time is too short. 2. Error of dynamic brake for deceleration. 3. The load is too heavy. 	<ol style="list-style-type: none"> 1. Increase the deceleration time. 2. Check the dynamic brake. 3. Check whether the motor cannot be stopped as it is driven by another load.
E21	PID feedback disconnection	<ol style="list-style-type: none"> 1. The PID feedback is greater than the upper limit (F09.24) or less than the lower limit (F09.25), depending on the type of the feedback sensor. 	<ol style="list-style-type: none"> 1. Check whether the feedback line falls off. 2. Check whether the sensor is working abnormally. 3. Adjust the detection value of feedback disconnection to a reasonable level.
E24	Self-identification error	<ol style="list-style-type: none"> 1. Press the STOP/RESET key during parameter identification. 2. The external terminal stops working (FRS = ON) properly during parameter identification. 3. The motor is not connected. 4. The rotary self-learning motor is not disconnected from the load. 5. The motor fails. 	<ol style="list-style-type: none"> 1. Press the STOP/RESET key to reset. 2. The external terminal should not be operated during parameter identification. 3. Check the connection between the inverter and motor. 4. Disconnect the rotary self-learning motor from the load. 5. Check the motor.
E26	Load loss protection	<ol style="list-style-type: none"> 1. The motor is not connected or does not match the load. 2. Load loss occurs. 3. The parameters of load loss protection are not set reasonably. 	<ol style="list-style-type: none"> 1. Check the wiring and use the appropriate motor 2. Check the equipment. 3. Change the off-load detection level F07.22 and detection time F07.23.
E27	Up to cumulative power-on time	<ol style="list-style-type: none"> 1. The inverter maintenance time is up. 	<ol style="list-style-type: none"> 1. Please contact the dealer for technical support.
E28	Up to cumulative running time	<ol style="list-style-type: none"> 1. The inverter maintenance time is up. 	<ol style="list-style-type: none"> 1. Please contact the dealer for technical support.
E44	Wiring protection	<ol style="list-style-type: none"> 1. The valid time of the wiring detection terminal is too long. 2. The invalid time of the wiring detection terminal is too long. 	<ol style="list-style-type: none"> 1. Check whether the sensor can work normally. 2. Check whether the terminal is capable of properly judging the closing and opening.
E57	Overpressure in pipeline network	<ol style="list-style-type: none"> 1. The feedback pressure in the water supply application is too high. 	<ol style="list-style-type: none"> 1. Check whether the sensor is in the abnormal status. 2. Check the analog terminal for normal detection of analog input. 3. Check the external device.
E58	Under-pressure in pipeline network	<ol style="list-style-type: none"> 1. The feedback pressure in the water supply application is too low. 	<ol style="list-style-type: none"> 1. Check whether the sensor is in the abnormal status. 2. Check the analog terminal for normal detection of analog input.

EM730 Solar Pump Inverter User Manual V1.0

Protection code	Protection Type	Protection Cause	Protection Solution
			3. Check the external device.
<i>E7E</i>	Short circuit to the ground	<ol style="list-style-type: none"> 1. The output is short-circuited to ground. 2. The inverter module is damaged. 	<ol style="list-style-type: none"> 1. Check whether the output cable is broken or whether the motor shell is broken down. 2. Investigate the cause and reset the controller after implementing the corresponding solutions. 3. Seek technical support.
<i>EESLP</i>	Water shortage dormancy	<ol style="list-style-type: none"> 1. The water in the water intake area is drained 2. The low-level detection sensor is damaged 	<ol style="list-style-type: none"> 1. Check whether there is water in the water intake area 2. Replace the low-level detection sensor
<i>FUSLP</i>	Full water storage tank sleep	<ol style="list-style-type: none"> 1. The water level in the water storage area is full 2. The high-level detection sensor in the water storage area is damaged 	<ol style="list-style-type: none"> 1. Check whether the water level in the water storage area is full 2. Replace the high-level detection sensor
<i>UBSLP</i>	Weak light sleep	<ol style="list-style-type: none"> 1. Insufficient light intensity 2. Light weak voltage value is set higher 	<ol style="list-style-type: none"> 1. Wait for the light to become stronger before it automatically recovers 2. Appropriately reduce the light detection voltage
<i>drSLP</i>	Dry running sleep	<ol style="list-style-type: none"> 1. The water flow of the water pump is very small or there is no water 2. The dry-run detection current is set larger 	<ol style="list-style-type: none"> 1. Change the water source 2. Appropriately reduce the dry-run detection current

Part 10 Optional accessories

10.1 Boost module

10.1.1 wiring

- PV+ and PV- of the boost module are connected to the positive and negative inputs of the DC power supply;
- +) and (-) of the boost module are connected to the input (+) and (-) of the water pump inverter ;
- 85 communication terminal A+ of the boost module is connected to the A+ of the inverter , and the A- terminal is connected to the A- ;
- After checking that the wiring is correct, it can run automatically after power-on.

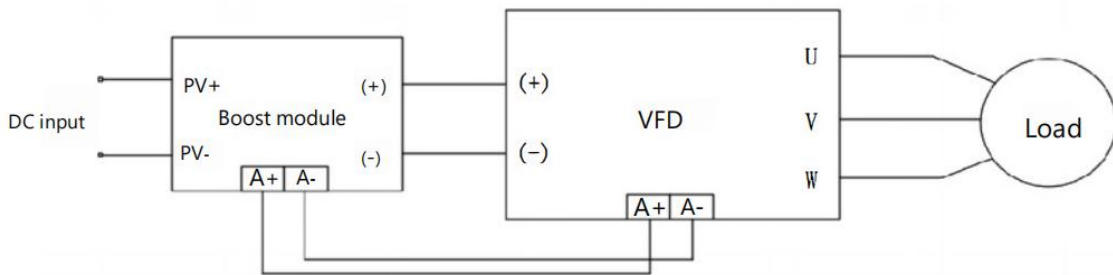

figure 1 Connection between boost module and inverter

10.1.2 Operation and operation process

① Automatic voltage boost

the input voltage of the boost module is below 260V , the voltage will be automatically increased to 260V ; if the input voltage is greater than 260V , the boost module will not boost the voltage temporarily; after the inverter is running and communicates successfully with the boost module, it will automatically boost the voltage according to the reference voltage of the inverter (the boost value of the inverter with a reference voltage of 220V is 350V , and the boost value of the inverter with a reference voltage of 380V is 570V).

② Inverter function code

F52 group boost module dedicated group

Function Code	Function code name	Parameter Description	unit	Factory default
F52.00	Whether to enable the boost module	0: Disable 1: Enable		1
F52.01	Reference voltage	0~690	V	0
F52.02	Voltage loop Kp	0.00~65.535		0.270
F52.03	Voltage loop Ki	0.00~65.535		0.135
F52.04	Current loop Kp	0.00~65.535		
F52.05	Current loop Ki	0.00 ~ 65.535		
F52.06	Carrier frequency	0 ~ 50	KZ	
F52.07	Light-weak voltage warning value setting	0~690	V	260
F52.08	Light intensity voltage warning value setting	0~690	V	690
F52.09	Motor overload factor	0.00~100.00	%	100.00
F52.10	Inverter side fault flag	0: No fault 1: Fault		0
F52.11	Boost side open circuit voltage	0~690	V	0
F52.12	Boost side open circuit current	0.00~650.00	A	0.00
F52.13	Low light intensity warning sign	0: No warning 1: Low light 2: High light		0
F52.14	Inverter operation selection when boost module fails	0: Inverter stops working 1: Warning output continues to operate with limited power		1

illustrate:

- Function code F 52.00 should be set to 1. If the DC bus voltage does not match after the inverter is powered on, check whether the F52.00 function code is 1;
- Function code F 52.01 means the inverter automatically sets parameters according to the rated voltage, without manual setting.
- Function codes F 52.02 and F 52.03 are the Kp and Ki parameters of the voltage loop PI and do not need to be changed ;

- Function codes F52.04 and F52.05 are the Kp and Ki parameters of the current loop PI and do not need to be changed;
- Function code F52.06 is for setting the carrier frequency of the boost module.
- Function codes F 52.0 7 and F 52.0 8 can set the light-weak warning voltage value and light-intensity warning voltage value. When the input voltage is less than the light-weak warning voltage value, the boost module fault light is on and the inverter pops up a light-weak warning; when the input voltage is greater than the light-intensity voltage value, the boost module fault light is on and the inverter pops up a light-intensity warning;
- Function code F 52.0 9 is used to set the overload factor and judge the input current for overload protection. 100% corresponds to the rated current of the boost module .
- Function code F 52. 11 displays the input voltage on the PV+ and PV- sides of the boost module; function code F 52. 12 displays the current on the PV+ and PV- sides of the boost module.
- F 52. 13 shows the warning sign on the boost module side, if the light is weak it is 1 and the light intensity is 2.

10.1.3 Working conditions

Input is the DC voltage of the photovoltaic panel

Maximum DC input voltage: 600V

Starting voltage: 80V

Minimum operating voltage: 70V

Maximum input current: 22A

10.1.4 Warnings and faults

Light intensity warning: When the light intensity is detected, the inverter pops up a warning, the red light of the boost module lights up, and the boost does not stop.

Weak light warning: When weak light is detected, the inverter pops up a warning, the red light of the boost module turns on, and the boost does not stop.

Communication failure. After the communication failure, the boost module automatically reduces the voltage to 260V (when the input voltage on the PV+ and PV- sides is less than 260V) or the input voltage on the PV + and PV- sides; the boost module automatically boosts the voltage after the communication is reconnected.

10.2 LCD keyboard

- ①LCD keyboard can display 3 lines of data
- ②Support parameter upload and download

10.2.1 wiring

Use a network cable to directly connect the inverter RJ45 network port and the LCD keyboard network port, and then the LCD keyboard can be used normally.

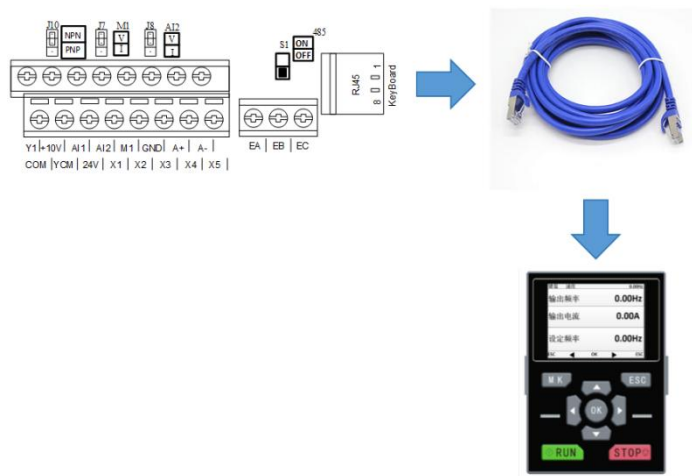

10.3 GPRS module

Optional GPRS module, providing WEB for remote monitoring by customers

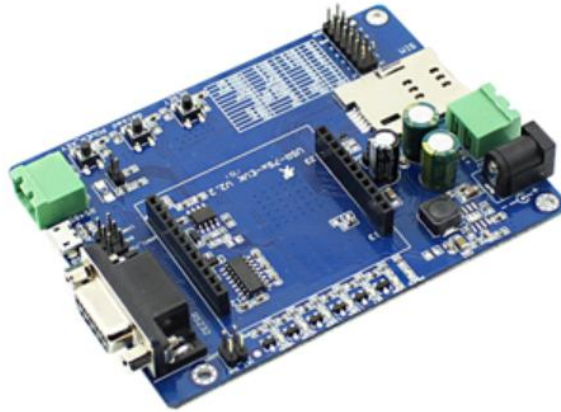

10.4 Output reactor

It can increase the effective transmission distance of the frequency converter and is suitable for long cable water pump application

